

STANDARD B-8 BOLLARD

APPROVAL:

Signature authorizes Tournesol Siteworks to manufacture the product as shown

SIZE AND THICKNESS

ALL STANDARD BOLLARDS MADE IN POWDER-COATED MILD STEEL W/ZINC-RICH PRIMER

BOLLARD
6"

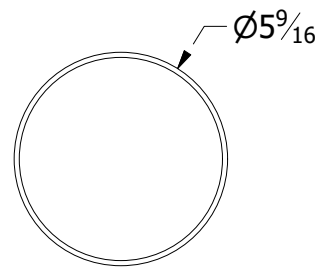

5" SCH 10 MS

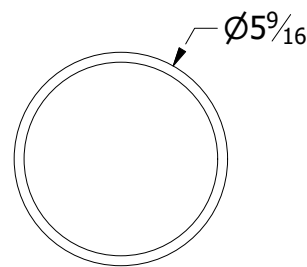

5" SCH 40 MS

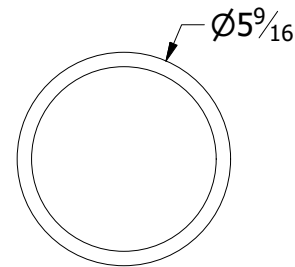

5" SCH 80 MS

HEIGHT

30"

36"

42"

48"

CUSTOM
(SEE PAGE 2)

TOPS AVAILABLE

B-8A

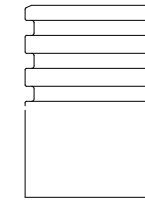

B-8B

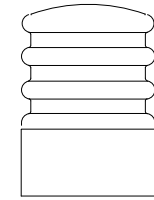

MOUNTING

SURFACE MOUNT (SM)

EMBED

REMOVABLE (REM)

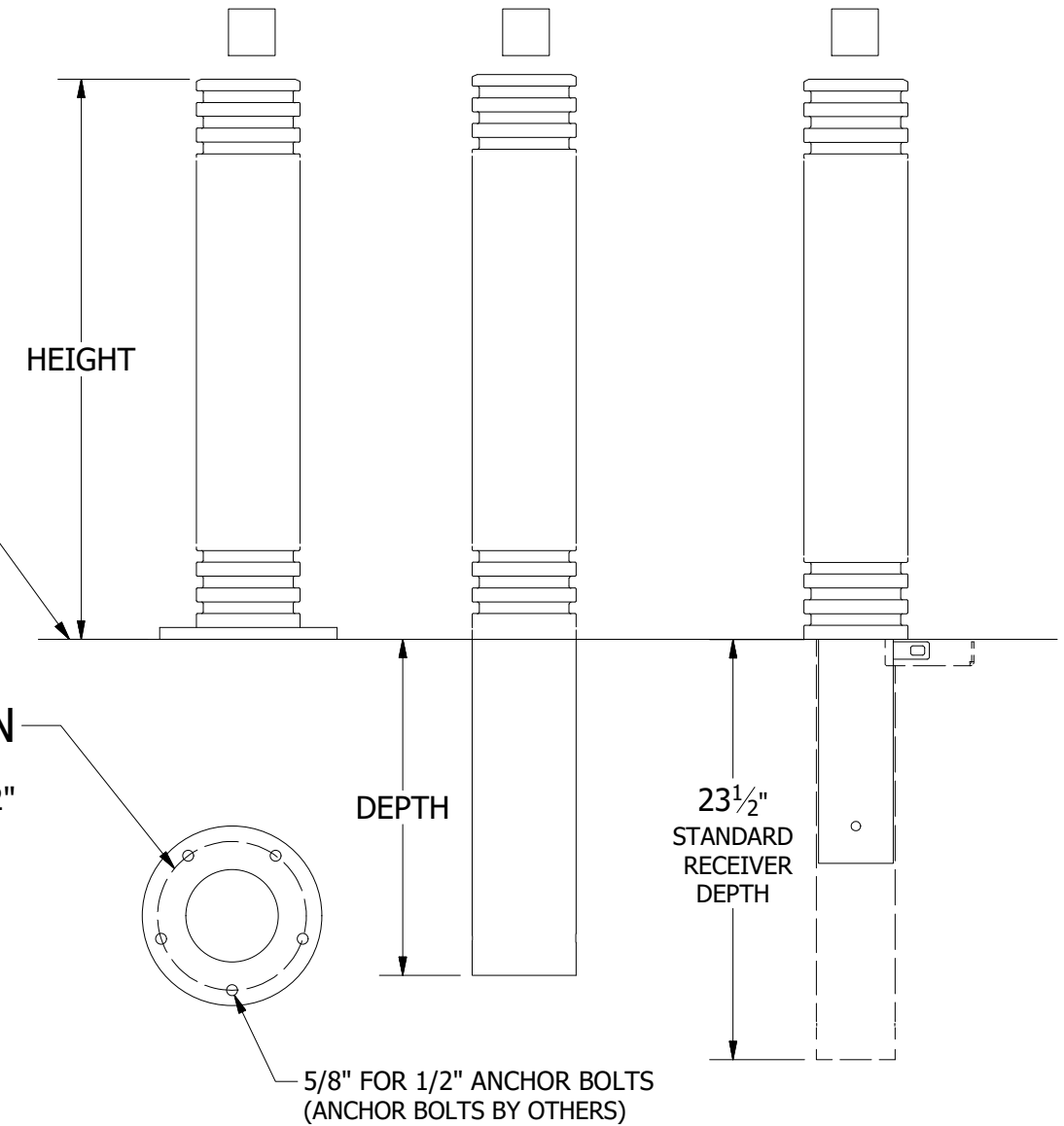

STANDARD DEPTH

6" REM BOLLARD = 12" DEEP

6" EMBED BOLLARD = 18" DEEP

8" BOLLARD = 18" DEEP

CUSTOM (SEE PAGE 2)

COMPANY NAME: _____
 CLIENT NAME: _____
 DATE: _____
 QUANTITY: _____
 COLOR/FINISH: _____

 TOURNESOL SITEWORKS 2930 Faber Street Union City, CA 94587		TITLE B-8 APPLICATION SHEET	
SIZE B	DWG NO B-8 APPLICATION SHEET	SCALE: 3/32	DRAWN: DM
ALL DIMENSIONS IN INCHES		7/21/2017	SHEET: 1 OF 2

B-8 BOLLARD OPTIONS

(FOR FURTHER CUSTOMIZATION, CONTACT YOUR SALES PERSON)

APPROVAL:

Signature authorizes Tournesol Siteworks to manufacture the product as shown

EYELET (B-EB) (IF NONE WANTED LEAVE BLANK)

Quantity: _____ Number of EYELETS

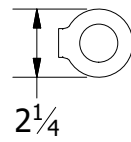

Placement: _____ " Height from the ground to the center of EYELET

Orientation(s): Shade in bubbles to indicate position

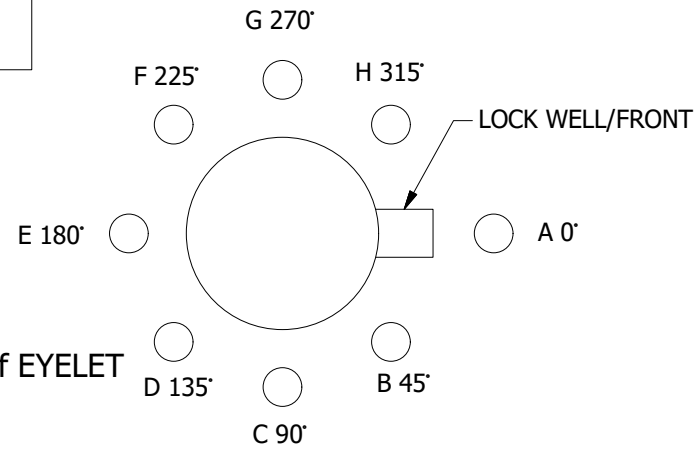

HANDLE (B-HD) (IF NONE WANTED LEAVE BLANK)

CHOOSE HOW MANY

1 HANDLE 2 HANDLES

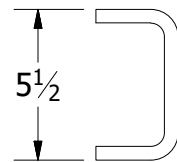

Placement: _____ " Height from the ground to the center of HANDLE

Orientation(s): Shade in bubbles to indicate position

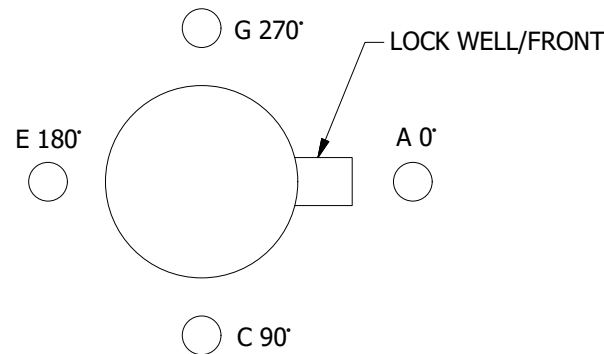

TAPE (B-TAPE) (IF NONE WANTED LEAVE BLANK)

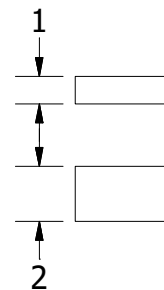

CHOOSE A WIDTH

1" TAPE 2" TAPE OTHER SIZES AVAILIABLE

CHOOSE A COLOR

HIGH INTENSITY IN RED WHITE YELLOW

ADDITIONAL ROW OF TAPE

Width _____

Type _____

Color _____

Placement _____ "

ADDITIONAL ROW OF TAPE

Width _____

Type _____

Color _____

Placement _____ "

Placement: _____ " Height from the ground to the center of TAPE

B-HTG _____ (IN)
(CUSTOM HEIGHT)

B-EXT _____ (IN)
(CUSTOM DEPTH)
(FOR EMBED OR REM)

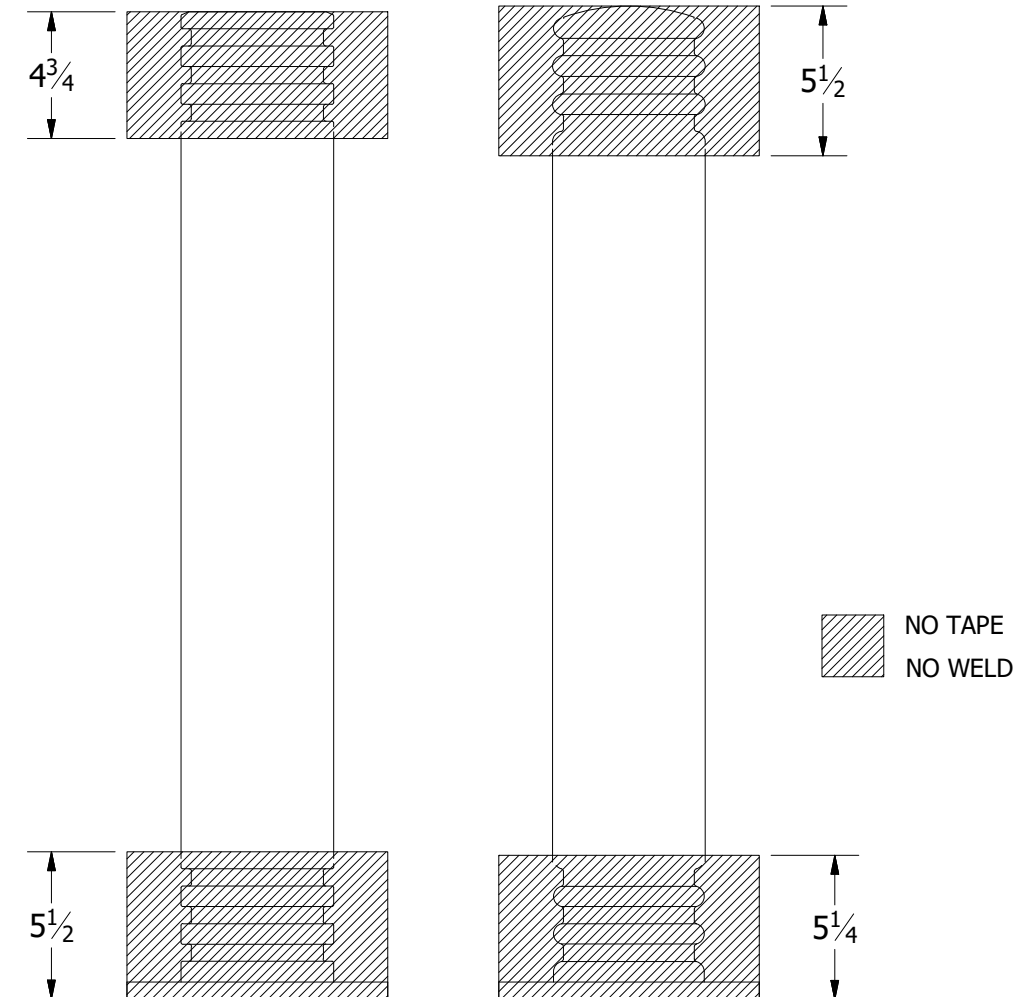

COMPANY NAME: _____
 CLIENT NAME: _____
 DATE: _____
 QUANTITY: _____
 COLOR/FINISH: _____